

2023

VOL - 1



AUDIOCENTER
Dynamic Audio Solutions

faital PRO

AUDIBLE AVENUE LLP

Fidek



Visit our website
www.aeronsindia.com



॥ ॐ नमो सिद्धिविनायक विश्वविनायक नमः ॥

Aerons India is Grateful for the Blessings of Its Elders



Late Shri Ram Gopal Gupta
[Founder]



Late Shri Prem Parshad Aeron

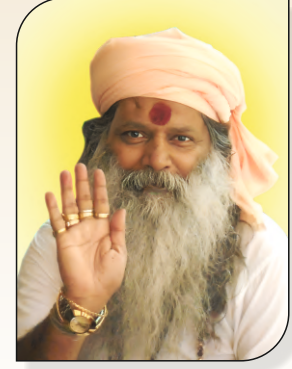

Guru Shri Swami Anand Ji

ABOUT US

AERONS (INDIA) EXIM PRIVATE LIMITED (previously AERONS (INDIA)) was founded in 1962 with the goal of providing the best quality audio equipments at the most competitive prices. We started off as manufacturers of Radios and Speakers but turned the company into a one-star merchant export house in the year 2000.

Today, we are one of the leading traders, exporters, and multi-brand distributors of Professional Audio Equipments in India. We cater to a large number of clients across the globe. Ours is a client-oriented organization, which provides professional audio solutions.

Under the valuable guidance of our Directors, Mr. A.K. Gupta & Mr. Ankit Gupta AERONS is among the Top Five Indian Brands in the Pro Audio market. Their extensive industry experience and expertise along with our highly proficient team of experts enables us to bring the latest technology, genuine quality, and innovative solutions to our customers at a competitive price.

PRODUCTS OFFERED

We provide a vast range of Professional Audio equipment like amplifiers, Speaker components, Compression Drivers, Mixers, Wired/Wireless Microphones, and other associated products. We are the Authorised Exclusive Distributors to Leading international Brand like **AUDIOCENTER**, **FAITALPRO**, **FIDEK**, etc for PAN INDIA. With the help of our vast and proud dealer network, we can cater to every need of our customers all over India. Our products are sought after by professional sound rental Companies, Schools, Cinemas, DJs, Hotels, Clubs, and Restaurants.

We aim to provide the best innovative solutions to cater to the needs of high-quality Audio users. We have been providing our clients with the very best in terms of technology & services. We have an extensive dealer network across 21 states in India We have passion for what we do and we pursue excellence to create the best value and experience for our customers.

**OUR
GOAL**

TABLE OF CONTENTS

1. POWER AMPLIFIER	2-7
▶ FIT Series	3
▶ R Series	4
▶ AJ Series	4
▶ HD Series	5
▶ LA Series	5
▶ CA Series	6
▶ SUBK Series	7
▶ RMX HD Series	7
2. SPEAKER COMPONENTS	8-18
▶ 21-Inch Loudspeaker	9
▶ 18-Inch Loudspeaker	10
▶ 15-Inch Loudspeaker	13
▶ 12-Inch Loudspeaker	16
▶ 10-Inch Loudspeaker	18
▶ 8-Inch Loudspeaker	18
3. COMPRESSION DRIVER	19-23
4. LINE ARRAY	24-27
5. TOURING SOUND SYSTEM	28-34
6. LIVE MIXER	35-39
▶ AMX Series	36
▶ SG Series	37
▶ ASM Series	38
▶ MX Series	39
7. DJ MIXER	40
8. DIGITAL SOUND PROCESSOR	41
9. CROSSOVER, EQUALIZER, SPLITTER	43
10. PORTABLE SPEAKER SYSTEM	43
11. INSTALLATION SERIES	44-46
▶ AI Series	45
▶ NF Series	46
▶ WS Series	46
12. ACCESSORIES	47
13. AUDIBLE AVENUE	48-49
14. AUDIOCENTER	50-56
▶ SA3 Series	51
▶ MA Series	53
▶ Active Line Array and Bass	54
▶ Passive Line Array and Bass	55
▶ PRO Amplifier	56
15. AUTHORISED DEALER NETWORK	57

POWER



AMPLIFIERS

CLIP XLR IMPEDENCE
OHM
NEUTRIC PARALLEL CLASS
SPEAKON
SOFT START PROFESSIONAL
LIMIT VOLUME WATTS
SIGNAL
IMPEDENCE
CIRCUITRY SMPS
MID CLIP
HIGH SPEAKON
BASS LIMIT
VIBRATION DAMPING
LOW IMPEDENCE
CONNECTOR POWER
PROTECTION STEREO
SMPS
TRANSFORMER BRIDGE
FREQUENCY RESPONSE SENSITIVITY
CIRCUIT DAMPING CONNECTOR POWER

FIT SERIES

Aeron's new FIT series offers brand new flexibility and high efficiency. Featuring mature D class technology, in a cost-effective 1U rack height, designed for small to middle-range sound system. The use of the Power Factor Correction(PFC) shows Aeron's target in energy saving, PFC will hugely improve performance and contain mains current draw and consumption. As the newest addition to Aeron's touring line of amplifier, FIT series is launched for requirements of cost-effective and high-performance. Available in both 2-channel and 4-channel, with per channel power ranges from 500W to 1800W.



FIT AND LEAN AMPLIFIERS



- ▶ 1U height 9" width of the standard cabinet, compact size, lightweight, and portable.
- ▶ Class D power amplifier module provides 92% high working efficiency and outputs high power density.
- ▶ Regulated-Switch Mode Power Supply(R-SMPS) ensures constant power output at all times.
- ▶ The Active Power Factor Correction (PFC) ensures the amps can work in working voltage ranges from 90V to 260V.
- ▶ Precision Power, Signal, CLIP, PROT to monitor performance
- ▶ Independent limiters per channel offer reliable protection against overload and distortion.
- ▶ Independent DC and thermal protection on each channel automatically protect the amplifier and speaker without shutting down the show.
- ▶ Comprehensive protection scheme including current, voltage, DC, temperature, short circuit, and open load warnings
- ▶ "Front to rear" ventilation system avoids uncomfortable feelings when operating the amps from the front panel.
- ▶ High quality electronic elements and extraordinarily robust construction ensure a long life span.
- ▶ Efficient cooling system dissipates more heat for extended peak output
- ▶ Designed by AERONS INDIA, India.

Model No	FIT 4X800	FIT 2X1000	FIT 2X3000
8 Ohms	4x500W	2x600W	2x1800W
4 Ohms	4x800W	2x1000W	2x3000W
8 Ohms Bridge	2x1600W	2000W	6000W
Output Circuitry	CLASS D		
Damping Factor (1kHz, 8Ω)	≥600	≥800	≥1500
Frequency Response	20Hz-20kHz		
Input Sensitivity	0.775V/1V/32dB		
S/N Ratio	≥106dB		
Crosstalk	≥70dB		
Slew rate	20V/uS		
Mode	Stereo/Parallel/Bridge		
Power Supply	SMPS		
Weight	4.8KG	4.2KG	6.5KG



R SERIES

R series is the most cost effective transformer power amplifier which is suitable for small to middle sized performances. Adopts mature Class AB, Class H and Class TD circuit layout, R series is of high stability and reliability. It provides different options of 2 channels, 3 channels and 4 channels amplifiers with power range from 350W to 1200W.



COST EFFECTIVE AMPLIFIERS

Model No	R1000	R2000	R3000	R5504
8 Ohms	2x350W	2x600W	2x750W	4x350W
4 Ohms	2x550W	2x850W	2x1200W	4x550W
8 Ohms Bridge	960W	1560W	2100W	2x960W
Output Circuitry	Class AB			
Damping Factor(1kHz, 8Ω)	≥150	≥160	≥200	≥150
Frequency Response	20Hz-20kHz (±1dB)			
Sensitivity (8Ω stereo)	0.7V/1V/1.4V			
S/N Ratio	≥97dB		≥96dB	≥97dB
Crosstalk	≥65dB		≥60dB	
Slew Rate	15V/μs			
Mode	Stereo/Parallel/Bridge			
Weight	13.04kg	15.04kg	17.6kg	17.6kg

Model No	R2400	R3200	R5200	R3600
8 Ohms	2x500W	2x900W	2x1200W	2x350W+900W
4 Ohms	2x800W	2x1500W	2x2000W	2x550W+1100W
8 Ohms Bridge	1600W	3000W	4000W	-
Output Circuitry	Class H	Class TD		Class AB
Damping Factor(1kHz, 8Ω)	≥250			≥150
Frequency Response	20Hz-20kHz (±0.5dB)		20Hz-20kHz (±1dB)	
Sensitivity (8Ω stereo)	0.775V/36dB/32dB		1.4V	0.7V/1V/1.4V
S/N Ratio	≥95dB		≥97dB	
Crosstalk	≥70dB		≥60dB	
Slew Rate	15V/μs			
Mode	Stereo/Parallel/Bridge		Stereo	Sub/Full, Bass/treble
Weight	16.75kg	19.5kg	20.6kg	17.8kg

AJ SERIES

AJ Series is a two-channel power amplifier series meticulously designed for the professional market. It adopts class H+ and AB circuit design to eliminate the common Class H and AB cross switching distortion. High-quality and sophisticated materials and craftsmanship ensure the high fidelity and high damping factor of AJ series. It can be used to drive various high-power speakers and monitor speakers that have critical requirements on the high-frequency performance.

Model No	AJ2504	AJ4002	AJ11002	AJ15002	AJ7003
8 Ohms	4x100W	2x200W	2x600W	2x800W	2x250W+550W
4 Ohms	4x125W	2x300W	2x900W	2x1200W	2x400W+850W
8 Ohms Bridge	2x250W	600W	1800W	2400W	-
Output Circuitry	Class AB			Class H	Class AB
Damping Factor(1kHz, 8Ω)	≥200	≥300	≥200	≥300	≥200
Frequency Response	20Hz-20kHz (±0.5dB)				
S/N Ratio	≥100dB				
Crosstalk	≥60dB				
Slew Rate	25V/μs				
Total Harmonic Distortion	≤0.1%				
Weight	7kg	16kg	17.6kg	20.5kg	18kg



HD SERIES

The HD 4001, HD 5001, HD 7001 & HD 9001 have everything a professional DJ's & Musicians requires. They need excellent sound quality, road-worthy toughness and reliability, low noise operation and incredible power. With 2600, 4000, 5200 & 6200 Watts respectively, the HD 4001, HD 5001, HD 7001 & HD 9001 are perfect for medium & large sized club gigs, mobile PA systems, Holy services or public space. Precise Power, Signal, Clip LEDs to monitor performance. Neutrik XLR and 1/4" TRS input connectors for compatibility with any source



Model No	HD4001	HD5001	HD7001	HD9001
8 Ohms	2x600W	2x1000W	2x1300W	2x1500W
4 Ohms	2x1000W	2x1600W	2x2000W	2x2400W
2 Ohms	2x1300W	2x2000W	2x2600W	2x3100W
8 Ohms Bridge	2000W	3200W	4000W	4800W
4 Ohms Bridge	2600W	4000W	5200W	6200W
Output Circuitry	Class H+			
Damping Factor(1kHz, 8Ω)	≥350	≥650	≥800	≥1000
Frequency Response	20Hz-20kHz (±2dB)			
Sensitivity (8Ω stereo)	0.775V,36dB,32dB			
S/N Ratio	≥105dB			
Crosstalk	≥60dB			
Slew Rate	≥40V/μs			
Crossover	High Pass: 160Hz, Low Pass: 160Hz			
Total Harmonic Distortion	≤0.5%			
Mode	Stereo/Parallel/Bridge			
Weight	25.7kg	34.76kg	39kg	42kg

THE PREMIUM AMPLIFIERS

LA SERIES

LA series is the most cost effective multi-channel transformer amplifier which is suitable for small to middle sized applications. Its excellent sound performance makes it be suitable for various functional requests. Equipped with pure copper heavy-duty toroidal transformer and assembled with high quality electronic elements, they can work stable at 4 ohm load easily with no sound distortion. Different circuit layouts drive them in the same stability and reliability. Multiple-protections and innovated heat radiation escort them can work for long term but low failure.

Model No	LA6004	LA14004	LA18004	LA21004
8 Ohms	4x400W	4x800W	4x1100W	4x1300W
4 Ohms	4x660W	4x1400W	4x1800W	4x2100W
8 Ohms Bridge	2x1300W	2x2800W	2x3600W	2x4200W
Output Circuitry	Class H+	Class H+	Class AB+D	Class AB+D
Damping Factor(1kHz, 8Ω)	≥250			≥800
Frequency Response	20Hz-20kHz (±0.5dB)			
Sensitivity (8Ω stereo)	0.775V/1V/32dB		26dB/32dB/38dB	
S/N Ratio	≥100dB		≥95dB	
Crosstalk	≥70dB			
Slew Rate	35V/μs			
Crossover	High Pass:160Hz, Low Pass:30Hz			
Mode	Stereo/Parallel/Bridge			
Weight	26.45kg	28.5kg	33.8kg	40kg



CA SERIES

CA Series is designed to give you dynamic sound spectrum, clean power with professional quality audio and power professional depend on. CA Series is designed with precise and comprehensive protection system, very nice sound dynamic together with costive engineering, thus to have higher quality-price ratio to ensure your bigger profit margins. Linear Powered, fan cooled , highly stable and ranging from 2U to 3U rack-mounting, these designs are capable of driving Speaker systems of 2 to 8 ohms impedance.



Model No	P7000II	CA4000II	CA5000II
8 Ohms	2x800W	2x800W	2x1000W
4 Ohms	2x1350W	2x1350W	2x1600W
2Ohms	2x1625W	2x1625W	2x2100W
8 Ohms Bridge	2700W	2700W	3400W
2 Ohms Bridge	3250W	3250W	4100W
Output Circuitry	Class H		
Damping Factor(1kHz, 8Ω)	≥300		
Frequency Response	20Hz-20kHz (±0.5dB)		
S/N Ratio	≥108dB		≥90dB
Total Harmonic Distortion	0.05%		
Input Sensitivity	1.4V		
Filter	Low Cut/Subwoofer/OFF		
Mode	Stereo/Parallel/Bridge		
Weight	24.6kg	29.4kg	28.5kg



MOST STABLE AMPLIFIERS

Model No	CA4500II	CA6500II	CA8500II
8 Ohms	2x800W	2x1500W	2x1800W
4 Ohms	2x1300W	2x2000W	2x3000W
2Ohms	2x1500W	2x2500W	2x3400W
8 Ohms Bridge	3000W	4000W	6000W
2 Ohms Bridge	3600W	5000W	6800W
Output Circuitry	Class H		
Damping Factor(1kHz, 8Ω)	≥500	≥800	
Frequency Response	20Hz-20kHz (±0.25dB)		
S/N Ratio	≥90dB		
Total Harmonic Distortion	0.05%		
Input Sensitivity	0.775V/1V/1.4V		
Filter	EQ Low Cut/Subwoofer/OFF		
Mode	Stereo/Parallel/Bridge		
Weight	33kg	46kg	47.5kg



SUB SERIES

SUBk series is developed for the pursuit of excellent sound quality with high density of power. Combined with dynamic power supply PWM modulation technology, SUBK series can perform to the need of high requirements in efficiency and quality. Equipped with pure copper heavy-duty toroidal transformer and assembled with high quality electronic elements, they can work stable at 4 ohm load easily with no sound distortion. Class AB+D circuit layouts drive them in the same stability and reliability. Multiple-protections and innovated heat radiation escort them can work for long term but low failure.

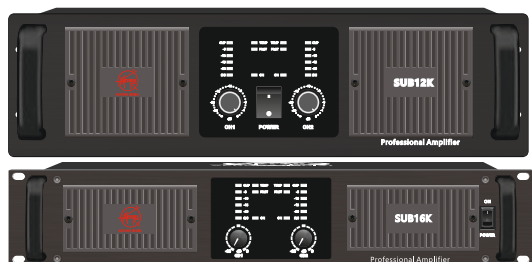

Model No	SUB12K	SUB16K
8 Ohms	2x2200W	2x2600W
4 Ohms	2x3600W	2x4800W
Output Circuitry	CLASS AB+D	
Damping Factor (1kHz,8Ω)	≥1000	≥1200
Frequency Response	20Hz – 20kHz	
S/N Ratio	≥95dB	
Crosstalk	≥70dB	
Slew rate	35V/uS	
Mode	Stereo	
Power Supply	Toroidal Transformer	SMPS
Weight	40.1KG	17.6KG

BRUTAL BASS AMPLIFIERS

RMX HD SERIES

The RMX HD Series power amplifiers represent the state-of-the-art in professional quality performance at an affordable price. Perfectly suited for a wide range of sound reinforcement applications including professional touring, performing musicians, and mobile entertainers, the RMX HD Series is optimized to deliver high levels of sustained power, extraordinary audio performance and road-proven reliability. The uber simple front panel controls of these amplifier gives you all of your sound's vital signs at a glance.

Model No	RMX HD 4050II	RMX HD 5050II
8 Ohms	2x1000W	2x1050W
4 Ohms	2x1500W	2x1600W
2Ohms	2x1800W	2x2000W
8 Ohms Bridge	3000W	3200W
2 Ohms Bridge	4400W	5000W
Output Circuitry	Class H	
Damping Factor(1kHz, 8Ω)	≥250	
Frequency Response	20Hz-20kHz (±0.5dB)	
S/N Ratio	≥100dB	
Input Sensitivity	1.25V	1.42V
Mode	Stereo/Parallel/Bridge	
Weight	30.8kg	33.6kg





SPEAKER COMPONENTS



21LF152

DUAL MAGNET
DUAL PUNCH



21" /545mm
CHASSIS DIAMETER

2500w (RMS)
POWER HANDLING

96.8_{dB}
SENSITIVITY (1w/1m)

30Hz - 1kHz
FREQUENCY RESPONSE

6" /152.2mm
VOICE COIL SIZE

300X25mm*2
FERRITE MAGNET SIZE



Neo Magnet

21SW152

21" /548mm
CHASSIS DIAMETER

2000w (RMS)
POWER HANDLING

97_{dB}
SENSITIVITY (1w/1m)

30Hz - 1.5kHz
FREQUENCY RESPONSE

6" /152.2mm
VOICE COIL SIZE

145X10mm
NEODYMIUM MAGNET SIZE



21SW115

21" /545mm
CHASSIS DIAMETER

2000w (RMS)
POWER HANDLING

96_{dB}
SENSITIVITY (1w/1m)

30Hz - 1kHz
FREQUENCY RESPONSE

4.5" /114.5mm
VOICE COIL SIZE

250X25mm*2
FERRITE MAGNET SIZE



DUAL MAGNET
DUAL PUNCH





PT186

- 18" / 487mm**
CHASSIS DIAMETER
- 2500w (RMS)**
POWER HANDLING
- 96.8_{dB}**
SENSITIVITY (1w/1m)
- 35Hz - 2kHz**
FREQUENCY RESPONSE
- 6" / 152.4mm**
VOICE COIL SIZE
- 330X25mm**
FERRITE MAGNET SIZE



DUAL MAGNET
DUAL PUNCH



1852

- 18" / 487mm**
CHASSIS DIAMETER
- 2400w (RMS)**
POWER HANDLING
- 97.8_{dB}**
SENSITIVITY (1w/1m)
- 30Hz - 1kHz**
FREQUENCY RESPONSE
- 5" / 126mm**
VOICE COIL SIZE
- 280X20mm*2**
FERRITE MAGNET SIZE



LF18X550

- 18" / 465mm**
CHASSIS DIAMETER
- 2200w (RMS)**
POWER HANDLING
- 99_{dB}**
SENSITIVITY (1w/1m)
- 30Hz - 2kHz**
FREQUENCY RESPONSE
- 5.3" / 135mm**
VOICE COIL SIZE
- 280X25mm**
FERRITE MAGNET SIZE



PT185/22

- 18" / 472mm**
CHASSIS DIAMETER
- 2000w (AES)**
POWER HANDLING
- 98_{dB}**
SENSITIVITY (1w/1m)
- 35Hz - 2kHz**
FREQUENCY RESPONSE
- 5" / 127mm**
VOICE COIL SIZE
- 280X25mm**
FERRITE MAGNET SIZE



18FE2000

18" /496mm
CHASSIS DIAMETER

2000w (RMS)
POWER HANDLING

97_{dB}
SENSITIVITY (1w/1m)

32Hz - 1kHz
FREQUENCY RESPONSE

5" / 125mm
VOICE COIL SIZE

280X25mm
FERRITE MAGNET SIZE



LF18X451

18" /465mm
CHASSIS DIAMETER

1800w (RMS)
POWER HANDLING

98_{dB}
SENSITIVITY (1w/1m)

32Hz - 1kHz
FREQUENCY RESPONSE

4.5" / 114.5mm
VOICE COIL SIZE

253X30mm
FERRITE MAGNET SIZE



18TBW115

18" /460mm
CHASSIS DIAMETER

1800w (RMS)
POWER HANDLING

98_{dB}
SENSITIVITY (1w/1m)

40Hz - 2kHz
FREQUENCY RESPONSE

4.5" / 114.15mm
VOICE COIL SIZE

245X29mm
FERRITE MAGNET SIZE



18FE1600

18" /461mm
CHASSIS DIAMETER

1600w (RMS)
POWER HANDLING

98_{dB}
SENSITIVITY (1w/1m)

30Hz - 1kHz
FREQUENCY RESPONSE

4" / 100mm
VOICE COIL SIZE

220x18mm*2
FERRITE MAGNET SIZE



**DUAL MAGNET
DUAL PUNCH** 



18TW100

18" /460mm
CHASSIS DIAMETER

1500w (RMS)
POWER HANDLING

100_{dB}
SENSITIVITY (1w/1m)

32Hz - 2kHz
FREQUENCY RESPONSE

4" /99.3mm
VOICE COIL SIZE

220X30mm
FERRITE MAGNET SIZE



18TBW100

18" /460mm
CHASSIS DIAMETER

1500w (RMS)
POWER HANDLING

96_{dB}
SENSITIVITY (1w/1m)

32Hz - 1kHz
FREQUENCY RESPONSE

4" /99.3mm
VOICE COIL SIZE

220X30mm
FERRITE MAGNET SIZE



COMING SOON

X452

*Await for the talk of the town ,
the most popular model revamped with Dual Magnet and Extra power*

NEW LOOK

MORE POWER

MORE PUNCH

DUAL MAGNET

15BM1200

15" / 393mm
CHASSIS DIAMETER

1200w (RMS)
POWER HANDLING

96_{dB}
SENSITIVITY (1w/1m)

45Hz - 3kHz
FREQUENCY RESPONSE

4" / 99.3mm
VOICE COIL SIZE

220X30mm
FERRITE MAGNET SIZE



PRO15/2226

15" / 394mm
CHASSIS DIAMETER

1000w (RMS)
POWER HANDLING

97.3_{dB}
SENSITIVITY (1w/1m)

45Hz - 3kHz
FREQUENCY RESPONSE

4" / 99.3mm
VOICE COIL SIZE

220X30mm
FERRITE MAGNET SIZE



MB15N351

कड़क MID

Neo Magnet

15" / 393mm
CHASSIS DIAMETER

650w (RMS)
POWER HANDLING

99_{dB}
SENSITIVITY (1w/1m)

40Hz - 3kHz
FREQUENCY RESPONSE

3.5" / 87mm
VOICE COIL SIZE

NEODYMIUM
MAGNET TYPE



कड़क MID

MB15X351

15" / 393mm
CHASSIS DIAMETER

650w (RMS)
POWER HANDLING

97_{dB}
SENSITIVITY (1w/1m)

50Hz - 2.5kHz
FREQUENCY RESPONSE

3.5" / 87mm
VOICE COIL SIZE

200X25mm
FERRITE MAGNET SIZE





MB15FE600

15" / 391mm
CHASSIS DIAMETER

600w (RMS)
POWER HANDLING

98_{dB}
SENSITIVITY (1w/1m)

40Hz - 4kHz
FREQUENCY RESPONSE

3.5" / 86mm
VOICE COIL SIZE

200X30mm
FERRITE MAGNET SIZE



PRO154F03

15" / 394mm
CHASSIS DIAMETER

600w (RMS)
POWER HANDLING

98_{dB}
SENSITIVITY (1w/1m)

44Hz - 2.5kHz
FREQUENCY RESPONSE

4" / 99.5mm
VOICE COIL SIZE

220X25mm
FERRITE MAGNET SIZE



PRO153F02

15" / 394mm
CHASSIS DIAMETER

500w (RMS)
POWER HANDLING

98_{dB}
SENSITIVITY (1w/1m)

49Hz - 3.5kHz
FREQUENCY RESPONSE

3" / 75mm
VOICE COIL SIZE

190X25mm
FERRITE MAGNET SIZE



15FW76II

15" / 393mm
CHASSIS DIAMETER

500w (RMS)
POWER HANDLING

98_{dB}
SENSITIVITY (1w/1m)

40Hz - 3kHz
FREQUENCY RESPONSE

3" / 76.2mm
VOICE COIL SIZE

190X25mm
FERRITE MAGNET SIZE



15PL76II

- 15" / 398mm**
CHASSIS DIAMETER
- 400w (RMS)**
POWER HANDLING
- 97^{dB}**
SENSITIVITY (1w/1m)
- 42Hz - 3.5kHz**
FREQUENCY RESPONSE
- 3" / 76.2mm**
VOICE COIL SIZE
- 190X20mm**
FERRITE MAGNET SIZE



15FE400



- 15" / 396mm**
CHASSIS DIAMETER
- 400w (RMS)**
POWER HANDLING
- 97.1^{dB}**
SENSITIVITY (1w/1m)
- 45Hz - 4.5kHz**
FREQUENCY RESPONSE
- 3" / 75mm**
VOICE COIL SIZE
- 170X20mm**
FERRITE MAGNET SIZE

Launching Soon

15BM1200

*With New Looks and Style
Superior Performance And Chrome Finish*



MB12X351

कड़क MID

12" /320mm
CHASSIS DIAMETER

650w (RMS)
POWER HANDLING

97 dB
SENSITIVITY (1w/1m)

60Hz - 2.5kHz
FREQUENCY RESPONSE

3.5" /87mm
VOICE COIL SIZE

200X25mm
FERRITE MAGNET SIZE



Neo Magnet

कड़क MID

MB12N351

12" /320mm
CHASSIS DIAMETER

650w (RMS)
POWER HANDLING

98 dB
SENSITIVITY (1w/1m)

50Hz - 2.5kHz
FREQUENCY RESPONSE

3.5" /87mm
VOICE COIL SIZE

NEODYMIUM
MAGNET TYPE



MB12N650.16

Neo Magnet

12" /316mm
CHASSIS DIAMETER

650w (RMS)
POWER HANDLING

96 dB
SENSITIVITY (1w/1m)

50Hz - 2.5kHz
FREQUENCY RESPONSE

3.5" /87.5mm
VOICE COIL SIZE

NEODYMIUM
MAGNET TYPE

16Ω



MB12FE600

12" /320mm
CHASSIS DIAMETER

600w (RMS)
POWER HANDLING

97.7 dB
SENSITIVITY (1w/1m)

50 Hz - 4kHz
FREQUENCY RESPONSE

3.5" /86mm
VOICE COIL SIZE

200X30mm
FERRITE MAGNET SIZE



PRO123F01

- 12" / 312mm**
CHASSIS DIAMETER
- 500w (RMS)**
POWER HANDLING
- 97.3^{dB}**
SENSITIVITY (1w/1m)
- 45Hz - 3.5kHz**
FREQUENCY RESPONSE
- 3" / 75mm**
VOICE COIL SIZE
- 190X25mm**
FERRITE MAGNET SIZE



कड़क MID

12MID.8



- 12" / 315mm**
CHASSIS DIAMETER
- 500w (RMS)**
POWER HANDLING
- 99^{dB}**
SENSITIVITY (1w/1m)
- 50Hz - 3kHz**
FREQUENCY RESPONSE
- 3" / 75mm**
VOICE COIL SIZE
- 200X30mm**
FERRITE MAGNET SIZE

12FW76II

कड़क MID

- 12" / 316mm**
CHASSIS DIAMETER
- 450w (RMS)**
POWER HANDLING
- 97^{dB}**
SENSITIVITY (1w/1m)
- 50Hz - 4kHz**
FREQUENCY RESPONSE
- 3" / 75.5mm**
VOICE COIL SIZE
- 190X25mm**
FERRITE MAGNET SIZE



16Ω

MB12FE250



- 12" / 318mm**
CHASSIS DIAMETER
- 250w (RMS)**
POWER HANDLING
- 95.6^{dB}**
SENSITIVITY (1w/1m)
- 50Hz - 18kHz**
FREQUENCY RESPONSE
- 2" / 51.5mm**
VOICE COIL SIZE
- 156X20mm**
FERRITE MAGNET SIZE



10MID.16

कड़क MID

10" /262mm
CHASSIS DIAMETER

500w (RMS)
POWER HANDLING

97.7_{dB}
SENSITIVITY (1w/1m)

64Hz - 3.5kHz
FREQUENCY RESPONSE

3" /75mm
VOICE COIL SIZE

200X30mm
FERRITE MAGNET SIZE

16Ω



MB8F300



8" /210mm
CHASSIS DIAMETER

300w (RMS)
POWER HANDLING

95_{dB}
SENSITIVITY (1w/1m)

55Hz - 4kHz
FREQUENCY RESPONSE

2.5" /65.5mm
VOICE COIL SIZE

156X20mm
FERRITE MAGNET TYPE

8MB250

8" /210mm
CHASSIS DIAMETER

250w (RMS)
POWER HANDLING

96_{dB}
SENSITIVITY (1w/1m)

80Hz - 7kHz
FREQUENCY RESPONSE

2" /49.5mm
VOICE COIL SIZE

140X20mm
FERRITE MAGNET SIZE



MB8FE200



16Ω

8" /212mm
CHASSIS DIAMETER

200w (RMS)
POWER HANDLING

96.1_{dB}
SENSITIVITY (1w/1m)

60Hz - 1.8kHz
FREQUENCY RESPONSE

2" /51.5mm
VOICE COIL SIZE

156X20mm
FERRITE MAGNET SIZE

COMPRESSION

High Frequency

DRIVER





4594N

210w (RMS)
POWER HANDLING

50mm
THROAT DIAMETER

115_{dB}
SENSITIVITY (1w/1m)

400Hz - 20kHz
FREQUENCY RESPONSE

3.6" & 1.76"
VOICE COIL SIZE

2.6KG
NET WEIGHT



COAXIAL
MF+HF

Neo Magnet

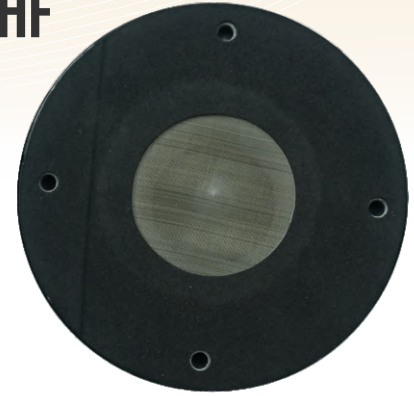

Neo Magnet



NEO990II

160w (RMS)
POWER HANDLING

40mm
THROAT DIAMETER

108_{dB}
SENSITIVITY (1w/1m)

1.2kHz - 20kHz
FREQUENCY RESPONSE

4" / 99.2mm
VOICE COIL SIZE

3.64KG
NET WEIGHT



DE1090TN

140w (RMS)
POWER HANDLING

50mm
THROAT DIAMETER

109_{dB}
SENSITIVITY (1w/1m)

500Hz - 20kHz
FREQUENCY RESPONSE

4" / 99.3mm
VOICE COIL SIZE

3.65KG
NET WEIGHT



Neo Magnet



BMD860

120w (RMS)
POWER HANDLING

50mm
THROAT DIAMETER

107_{dB}
SENSITIVITY (1w/1m)

900Hz - 18kHz
FREQUENCY RESPONSE

3" / 75mm
VOICE COIL SIZE

4.2KG
NET WEIGHT

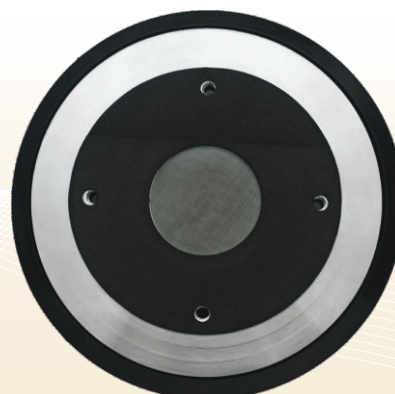

NEO880II

- 120w (RMS)**
POWER HANDLING
- 40mm**
THROAT DIAMETER
- 105_{dB}**
SENSITIVITY (1w/1m)
- 1.2kHz - 20kHz**
FREQUENCY RESPONSE
- 3" / 74.46mm**
VOICE COIL SIZE
- 2.24KG**
NET WEIGHT

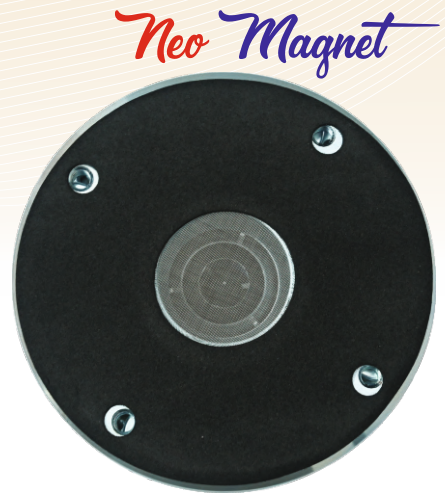

Neo Magnet

PRO-752FF



With Ferro Fluid



- 120w (RMS)**
POWER HANDLING
- 38mm**
THROAT DIAMETER
- 106_{dB}**
SENSITIVITY (1w/1m)
- 1kHz - 20kHz**
FREQUENCY RESPONSE
- 3" / 74.2mm**
VOICE COIL SIZE
- 4.7KG**
NET WEIGHT

DE750TN

- 110w (RMS)**
POWER HANDLING
- 50mm**
THROAT DIAMETER
- 107_{dB}**
SENSITIVITY (1w/1m)
- 500Hz - 18kHz**
FREQUENCY RESPONSE
- 4" / 74.46mm**
VOICE COIL SIZE
- 6.2KG**
NET WEIGHT



HF300TI

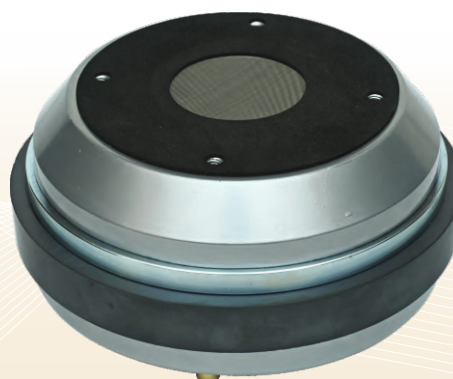

- 110w (RMS)**
POWER HANDLING
- 50mm**
THROAT DIAMETER
- 109_{dB}**
SENSITIVITY (1w/1m)
- 500 - 18kHz**
FREQUENCY RESPONSE
- 3" / 74.4mm**
VOICE COIL SIZE
- 5.2KG**
NET WEIGHT



DE85TN

110w (RMS)
POWER HANDLING

36mm
THROAT DIAMETER

107_{dB}
SENSITIVITY (1w/1m)

500Hz - 18kHz
FREQUENCY RESPONSE

3" / 74.46mm
VOICE COIL SIZE

4.5KG
NET WEIGHT

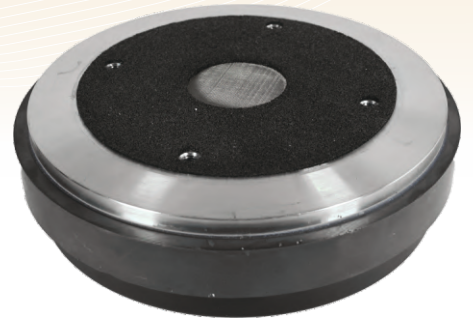

CD74A.16

90w (RMS)
POWER HANDLING

50mm
THROAT DIAMETER

108_{dB}
SENSITIVITY (1w/1m)

600Hz - 20kHz
FREQUENCY RESPONSE

3" / 75mm
VOICE COIL SIZE

4.25KG
NET WEIGHT

16Ω



HF520

80w (RMS)
POWER HANDLING

36mm
THROAT DIAMETER

109_{dB}
SENSITIVITY (1w/1m)

1.3kHz - 20kHz
FREQUENCY RESPONSE

2" / 51.6mm
VOICE COIL SIZE

2.83KG
NET WEIGHT



HF520S

80w (RMS)
POWER HANDLING

25.4mm
THROAT DIAMETER

109_{dB}
SENSITIVITY (1w/1m)

1.3kHz - 20kHz
FREQUENCY RESPONSE

2" / 51.6mm
VOICE COIL SIZE

2.83KG
NET WEIGHT



Neo Magnet

NEO440II

70w (RMS)
POWER HANDLING

25mm
THROAT DIAMETER

112_{dB}
SENSITIVITY (1w/1m)

1.2kHz - 20kHz
FREQUENCY RESPONSE

1.76" / 44.4mm
VOICE COIL SIZE

0.94KG
NET WEIGHT

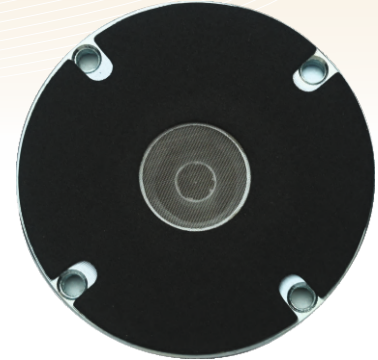

DE250



60w (RMS)
POWER HANDLING

25mm
THROAT DIAMETER

107_{dB}
SENSITIVITY (1w/1m)

1.2kHz - 18kHz
FREQUENCY RESPONSE

1.76" / 44.4mm
VOICE COIL SIZE

2.2KG
NET WEIGHT

Neo Magnet

HF34N

30w (RMS)
POWER HANDLING

25.4mm
THROAT DIAMETER

108_{dB}
SENSITIVITY (1w/1m)

1.5kHz - 18kHz
FREQUENCY RESPONSE

1.37" / 34.4mm
VOICE COIL SIZE

0.6KG
NET WEIGHT



HF102



20w (RMS)
POWER HANDLING

25.4mm
THROAT DIAMETER

108_{dB}
SENSITIVITY (1w/1m)

1.5kHz - 18kHz
FREQUENCY RESPONSE

1" / 25.4mm
VOICE COIL SIZE

0.7KG
NET WEIGHT



LINE ARRAY



AERONS[®]
AERONS (INDIA)

HDLA 12

- « 1X12" (300mm)/3.5" voice coil LF driver
- « 1x1.4" (36mm)/ 3" voice coil HF driver
- « Rated Power: 650W
- « Peak Power: 2600W
- « Sensitivity: 98dB 1watt/1Metre
- « Frequency Response: 60Hz- 20kHz \pm 3dB
- « Maximum SPL: 129dB
- « Net Weight: 27Kg/Pc



CONFIGURATION

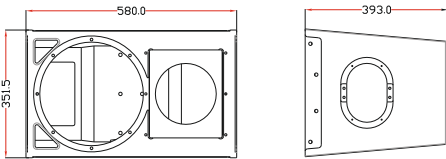

Neo Magnet



LA3032 V2

- « 1X12" (300mm)/3.5" voice coil Neo LF driver
- « 3x1" (25mm)/1.4" voice coil Neo HF driver
- « Rated Power: 750W
- « Peak Power: 1500W
- « Sensitivity: 99Db 1watt/1Metre
- « Maximum SPL: 129dB
- « Frequency Response: 50Hz- 20kHz \pm 3dB
- « Net Weight: 22Kg/pc

CONFIGURATION

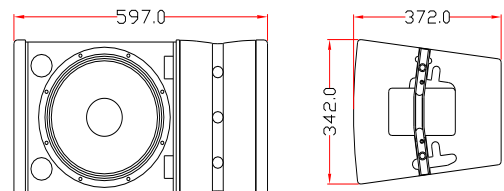

LA123

- « Cabinet with fitted Neo HF and Networks
- « 3x1" (25mm)/1.4" voice coil Neo HF driver
- « Rated Power: Based on Speaker
- « Peak Power: Based on Speaker
- « Sensitivity: Based on Speaker
- « Maximum SPL: Based on Speaker
- « Frequency Response (HF): 2kHz- 20kHz \pm 3dB



CONFIGURATION

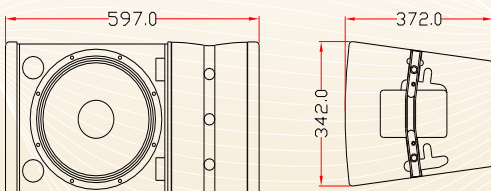



HDLA8055 V2

Neo Magnet

- « 1X12" (300mm)/3.5" voice coil Neo LF driver
- « 3x3" (83mm)/ 0.8" voice coil Neo MF driver
- « 2x1" (25mm)/1.7" voice coil Neo HF driver
- « Rated Power: 1000W
- « Peak Power: 4000W
- « Sensitivity: 100dB 1watt/1Metre
- « Frequency Response: 55Hz- 18kHz ±3dB
- « Maximum SPL: 132dB
- « Net Weight: 25Kg/pc



CONFIGURATION

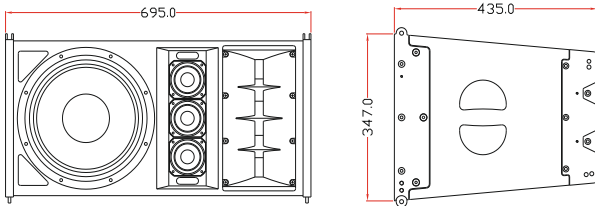

Neo Magnet



TT LA112

- « 1X12" (300mm)/3.5" voice coil Neo LF driver
- « 1x1.4" (36mm)/ 3.5" voice coil Neo MF driver
- « 1x1.4" (36mm)/1.7" voice coil Neo HF driver
- « Rated Power: 800W
- « Peak Power: 3200W
- « Sensitivity: 98Db 1watt/1Metre
- « Frequency Response: 50Hz- 20kHz ±3dB
- « Maximum SPL: 133dB
- « Net Weight: 28Kg/pc

CONFIGURATION

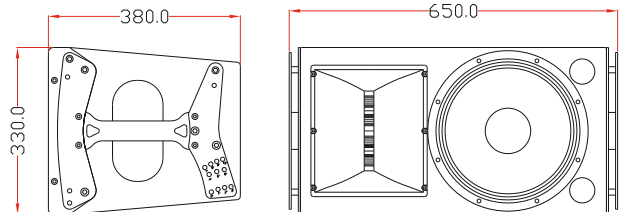

HDLA 15

- « 1X15" (385mm)/4" voice coil LF driver
- « 2x1.4" (36mm)/3" voice coil HF driver
- « Rated Power: 1000W
- « Peak Power: 4000W
- « Sensitivity: 99dB 1watt/1Metre
- « Frequency Response: 60Hz- 20kHz ±3dB
- « Maximum SPL: 131dB
- « Net Weight: 41Kg/pc

CONFIGURATION

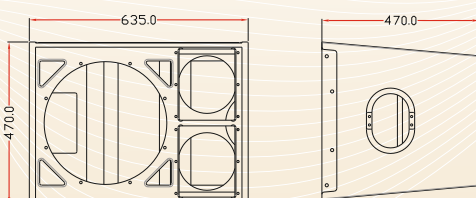

HDLA212 V2

- « 2X12" (300mm)/3.5" voice coil Neo LF driver
- « 2x1.4" (36mm)/3" voice coil Neo HF driver
- « Rated Power: 1500W
- « Peak Power: 6000W
- « Sensitivity: 102dB 1watt/1Metre
- « Maximum SPL: 137dB
- « Frequency Response : 55Hz- 18kHz ±3dB
- « Net Weight: 40Kg/pc



CONFIGURATION

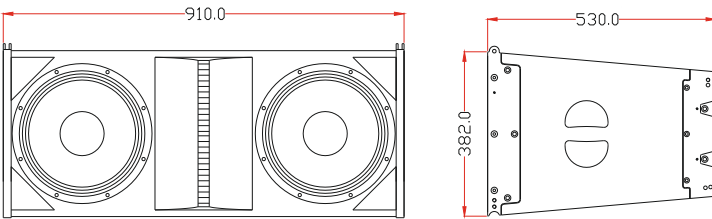

HDLA210 V2

- « 2X10" (250mm)/3" voice coil LF driver
- « 1x1.4" (36mm)/3" voice coil HF driver
- « Rated Power: 800W
- « Peak Power: 3200W
- « Sensitivity: 101dB 1watt/1Metre
- « Maximum SPL: 134dB
- « Frequency Response: 55Hz- 18kHz ±3dB
- « Net Weight: 33Kg/pc



CONFIGURATION

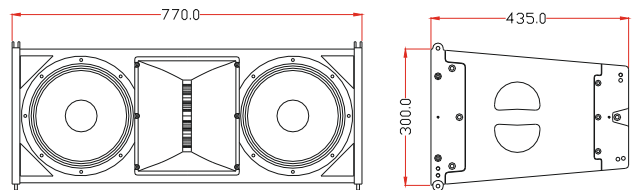

TTLA 3212

- « 2X12" (300mm)/3.5" voice coil Neo LF driver
- « 2x1.4" (36mm)/ 3.5" voice coil Neo MF driver
- « 2x1.4" (36mm)/ 1.7" voice coil Neo HF driver
- « Rated Power: LF=1300W, MF+HF=400W
- « Peak Power: LF=5200W, MF+HF=1600W
- « Sensitivity: 101dB & 110dB 1watt/1Metre
- « Frequency Response: LF=60Hz- 650Hz
MF+HF=500Hz- 18kHz
- « Maximum SPL: LF= 136dB, MF+HF=140dB



CONFIGURATION

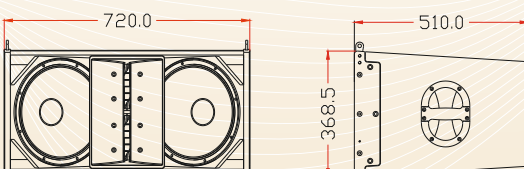



TOURING SOUND SYSTEM

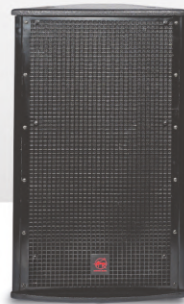
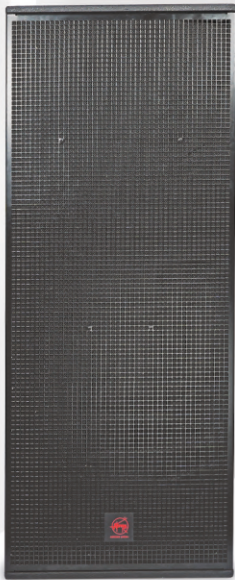

RIO SERIES

MADE IN INDIA



RiO 12

- « Single 12" Arrayable Top, Bass Reflex Design
- « 1x12" LF Driver with 4" Voice Coil (Faitalpro)
- « 1x1.4" HF Driver with 2" voice coil
- « 700W RMS power, 1400W Peak Power
- « Sensitivity: 99dB
- « SPL: 127dB, Peak SPL: 130dB
- « Frequency Response: 60Hz – 19kHz
- « Net Weight: 23 KGS



Arrayable Design



LF LOADED WITH



MADE IN INDIA



LOADED WITH
AERONS
HF520
15BM1200

RiO 15M

- « Single 15" Floor Monitor, Bass Reflex Design
- « 1x15" LF Driver with 4" Voice Coil
- « 1x1.4" HF Driver with 2" voice coil
- « 1200W RMS power, 2400W Peak Power
- « Sensitivity: 99dB
- « SPL: 127dB, Peak SPL: 130dB
- « Frequency Response: 50Hz – 19kHz
- « Net Weight: 37 KGS

High Performance
Aerons HF driver

15" High End Aerons
LF Driver with 4" Voice coil

Exceptional Sound Quality

Powder Coated
Steel Grille
for Durability and Sturdiness

Acoustical Foam
to protect drivers from dust

Elegant and Stylish
Stunning Cabinet Design

Pole mount
for standing operations

MADE IN INDIA
Made for India

Solid Wood Construction
and Unique Physical Acoustic design

Small Size, Big Power
Power: 1200W
Peak SPL: 130dB

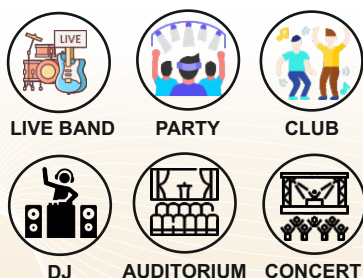

APPLICATIONS

MADE IN
 INDIA



AERONS
(INDIA)

TOURING SOUND SYSTEM

RiO 215

- « Dual 15" Full Range Cabinet, Bass Reflex Design
- « 2x15" LF Driver with 4" Voice Coil
- « 1x1.4" HF Driver with 3" voice coil (FaitalPro)
- « 1600W RMS power, 3200W Peak Power
- « Sensitivity: 101dB
- « SPL: 132dB, Peak SPL: 135dB
- « Frequency Response: 50Hz – 19kHz
- « Net Weight: 57.5 KGS

Exceptional Sound Quality



DJ



CLUB



CONCERT



PARTY



LIVE BAND



AUDITORIUM

APPLICATIONS

MADE IN INDIA

Made for India

Ergonomic Handles

for the ease of handling and transportation

Elegant and Stylish

Stunning Cabinet Design

HF LOADED WITH



Solid Wood Construction
and Unique Physical Acoustic design



High Performance
FaitalPro HF driver

Powder Coated
Steel Grille
for Durability and Sturdiness

2x15" High End
LF Driver with 4" Voice coil

Acoustical Foam
to protect drivers from dust

Front Loaded Driver

for Full range response

Gigantic Size, Big Power

Power: 1600W
Peak SPL:

MADE IN INDIA



Front Loaded Driver
for Hard Bass Punch

Solid Wood Construction
and Unique Physical Acoustic design

Acoustical Foam
to protect drivers from dust

Elegant and Stylish
Stunning Cabinet Design

Powder Coated

Steel Grille
for Durability and Sturdiness

Punchy Hard Bass

RiO 18SUB

- « 18" Hard Bass Subwoofer, Front Loaded Design
- « 1x18" LF Driver with 4.5" Voice Coil
- « 1800W RMS power, 3600W Peak Power
- « Sensitivity: 98dB
- « SPL: 130dB, Peak SPL: 133dB
- « Frequency Response: 38Hz – 1kHz
- « Net Weight: 54 KGS

LOADED WITH
BEST IN CLASS
LF18X451



Power: 1800W

MADE IN INDIA

TURBO SERIES

CRISP- SOUND

RELIABLE

PROFESSIONAL

POWERFUL

DISTORTION-FREE



Level Up Your Audio Experience with
TURBO  *Series*



TURBO 515

- « Single 15" Full Range/Floor monitor
- « 2-Way system with Professional Design
- « 1x15" LF Driver with 3" Voice Coil
- « 1x1" HF Driver with 1.75" voice coil
- « 550W RMS power, 1100W Peak Power
- « Nominal Impedance: 8 ohms
- « Sensitivity: 99dB
- « SPL: 125dB
- « Frequency Response: 50Hz – 19kHz
- « Colour : Coffee
- « Dual Angular Pole mount

Power: 550W



Applications

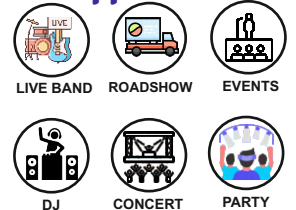

Power: 600W



TURBO 518

- « Single 18" PRO Subwoofer, Band Pass Design
- « High Performance Custom Transducer
- « 1x18" LF Driver with 4" Voice Coil
- « 600W RMS power, 1200W Peak Power
- « Nominal Impedance: 8 ohms
- « Sensitivity: 99dB
- « SPL: 128dB
- « Frequency Response: 35Hz – 250Hz
- « Colour : Coffee



Applications

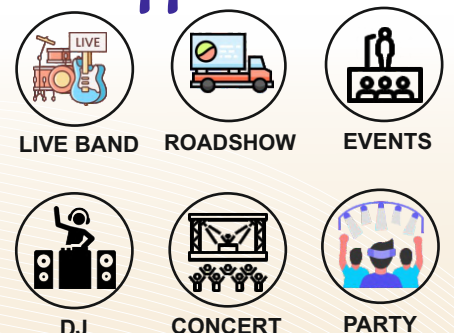

NEW LAUNCH

TURBO 525

- « Dual 15" Full Range PRO Cabinet Design
- « 2-Way system with elegant design
- « 2x15" LF Driver with 3" Voice Coil
- « 1x1.4" HF Driver with 3" voice coil
- « 850W RMS power, 1700W Peak Power
- « Nominal Impedance: 4 ohms
- « Sensitivity: 98dB
- « SPL: 128dB
- « Frequency Response: 50Hz – 18kHz
- « Colour : Coffee

Applications



LIVE BAND



ROADSHOW



EVENTS



DJ



CONCERT



PARTY

Power: 850W



TURBO 528

- « Dual 18" PRO Subwoofer, Front load Design
- « High Performance Custom Transducer
- « 2x18" LF Driver with 4" Voice Coil
- « 1600W RMS power, 3200W Peak Power
- « Nominal Impedance: 4 ohms
- « Sensitivity: 101dB
- « SPL: 135dB
- « Frequency Response: 30Hz – 250Hz
- « Colour : Coffee

NEW LAUNCH

PUNCHY  BASS

Power: 1600W



Applications



LIVE BAND



ROADSHOW



EVENTS



DJ



CONCERT



PARTY



NEW LAUNCH

TURBO 535

- « Dual 15" Full Range PRO Cabinet Design
- « 2-Way system with unique design
- « 2x15" LF Driver with 3" Voice Coil
- « 1x1.4" HF Driver with 3" voice coil
- « 1000W RMS power, 2000W Peak Power
- « Nominal Impedance: 4 ohms
- « Sensitivity: 98dB
- « SPL: 135dB
- « Frequency Response: 50Hz – 18kHz
- « Colour : Coffee

Applications



LIVE BAND



ROADSHOW



EVENTS



DJ



CONCERT



PARTY

Power: 1000W

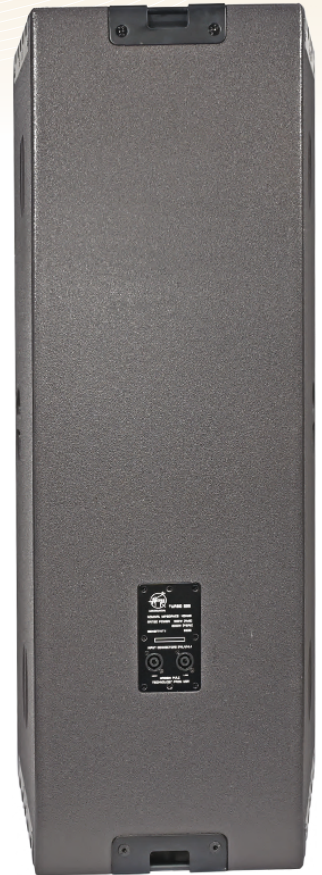

NEW LAUNCH

TURBO 545

- « Dual 15" Full Range PRO Cabinet Design
- « 3-Way system with Dual HF and LF Design
- « 2x15" LF Driver with 4" Voice Coil
- « 1x1.4" HF Driver with 3" voice coil
- « 1x1" HF Driver with 1.75" voice coil
- « 1300W RMS power, 2600W Peak Power
- « Nominal Impedance: 4 ohms
- « Sensitivity: 98dB
- « SPL: 135dB
- « Frequency Response: 40Hz – 19kHz
- « Colour : Coffee

Applications



LIVE BAND



ROADSHOW



EVENTS



DJ



CONCERT



PARTY

Power: 1300W





MIXERS





AMX SERIES

The AERONS AMX Series mixers are the most budget-conscious mixers for users who refuse to sacrifice sound quality and reliability. AMX series is the best-selling and most trusted mixer series in India. These mixers are built to match international standards and are ideal for professionals as well as amateurs. AMX series are compact professional mixers with direct USB playback and recording function. It also supports the use of Bluetooth digital playback equipment, such as mobile phones, tablets, Macs, and PC. It is suitable for various application scenes, including live performances, studio recordings, and fixed installations

AMX6U

- 6 Mic/Line +1 Stereo channel
- Build in 16-bit digital DSP effect.
- 3 Band EQ per channel.
- Built-in MP3 player with Bluetooth
- USB Port for Mp3 & Recording
- 1 AUX sending
- Direct SUB out with Controllers
- Internal universal power supply
- Metal chassis, built to last



AMX8U

- 8 Mic/Line +1 Stereo channel
- Build in 16-bit digital DSP effect.
- 3 Band EQ per channel.
- Built-in Mp3 player with Bluetooth
- USB Port for Mp3 & Recording
- 1 AUX sending
- Direct SUB out with Controllers
- Internal universal power supply
- Metal chassis, built to last

AMX12U

- 12 Mic/Line +1 Stereo channel
- Build in 16-bit digital DSP effect.
- 3 Band EQ per channel.
- Built-in Mp3 player with Bluetooth
- USB Port for Mp3 & Recording
- 1 AUX sending
- Direct SUB out with Controllers
- Internal universal power supply
- Metal chassis, built to last



With Graphic Equalizer

SG SERIES

The AERONS SG series combines the simplicity of the AMX series with the requirement of more complex professional applications. The SG Series boasts an extensive line-up of compact mixing consoles with models ranging from eight to sixteen channels, suitable for a diverse range of users and applications. The professional and affordable SG Series mixers feature high-quality components, a rugged metal chassis, and features designed for a variety of applications. SG series are professional mixers with direct USB playback and recording function. It also supports the use of Bluetooth digital playback equipment, such as mobile phones, tablets, Macs, and PC. SG Series is equipped with a high-quality 7-Band graphic equalizer for better performance and productivity.

SG803U

- 8 Mic/Line +1 Stereo channel
- Build in 16-bit digital DSP effect.
- 3 Band EQ per channel.
- Dual 7 band GEQ
- Built-in MP3 player with Bluetooth
- USB Port for Mp3 & Recording
- 3 AUX sending & 1 Return
- Direct SUB out with Controllers
- Internal universal power supply
- Metal chassis, built to last



SG1203U

- 12 Mic/Line +1 Stereo channel
- Build in 16-bit digital DSP effect.
- 3 Band EQ per channel.
- Dual 7 band GEQ
- Built-in MP3 player with Bluetooth
- USB Port for Mp3 & Recording
- 3 AUX sending & 1 Return
- Direct SUB out with Controllers
- Internal universal power supply
- Metal chassis, built to last

SG1603U

- 16 Mic/Line +1 Stereo channel
- Build in 16-bit digital DSP effect.
- 3 Band EQ per channel.
- Dual 7 band GEQ
- Built-in MP3 player with Bluetooth
- USB Port for Mp3 & Recording
- 3 AUX sending & 1 Return
- Direct SUB out with Controllers
- Internal universal power supply
- Metal chassis, built to last





ASM SERIES

With Dual Effects and Groups

The AERONS new ASM series combines the simplicity of the SG series with the requirement of more complex professional applications. the ASM Series comes with DUAL EFFECTS function and grouping function, it also boasts an extensive line-up of compact mixing consoles with models ranging from sixteen to twenty channels, suitable for a diverse range of users and applications. The professional and affordable ASM Series mixers feature high-quality components, a rugged metal chassis, and features designed for a variety of applications. ASM series are professional mixers with direct USB playback and recording function. It also supports the use of Bluetooth digital playback equipment, such as mobile phones, tablets, Macs, and PC. SG Series is equipped with a high-quality 7-Band graphic equalizer for better performance and productivity.

ASM16

- 12 Mic/Line +2 Stereo channel
- Build in 32-bit digital DSP effect.
- 3 Band EQ per channel.
- Dual 7 band GEQ
- Built-in Mp3 player with Bluetooth
- USB Port for MP3 & Recording
- 2 AUX sending & 1 Return
- 99 Effects with Dual effect function
- Group 1-2 and 3-4



DUAL EFFECTS

ASM22

- 18 Mic/Line +2 Stereo channel
- Build in 32-bit digital DSP effect.
- 3 Band EQ per channel.
- Dual 7 band GEQ
- Built-in Mp3 player with Bluetooth
- USB Port for MP3 & Recording
- 2 AUX sending & 1 Return
- 99 Effects with Dual effect function
- Group 1-2 and 3-4



DUAL EFFECTS

MX1007USB

- 5 Mic/Line +1 Stereo channel
- Build in 24-bit digital DSP effect.
- 3 Band EQ per channel.
- Built-in Mp3 player with Bluetooth
- USB Port for Mp3 & Recording
- 16 Effects
- 1 AUX sending



A802U

- 2 Mic/Line + 1 Stereo channel.
- Delay and Repeat Effect.
- 2 Band EQ per channel.
- Built-in MP3 player with Bluetooth
- USB Port for Mp3 & Recording
- Metal chassis, built to last





With Digital Effects

E-DJM

- « Rugged, reliable, and easy-to-operate 4-channel DJ mixer with effects.
- « Professional layout with 18 effects and a high-performance effect processor.
- « Effects on/off Switch with mix and parameter control
- « 3-Band EQ per channel for smoother mixing
- « Individual 10-segment LED array for indicating output levels
- « Smooth dual-rail 60mm channel fader
- « Fully assignable 45mm smooth dual-rail crossfader
- « Crossfader reverse/normal/flat/steep curve switch.
- « CF assign switch for the main or crossfader
- « USB port for direct plug and Play from the computer
- « 6.35 mm +3.5mm TRS Headphone output
- « PFL with Level and mix control and blend/split switch
- « Balanced XLR MIC input with dedicated Gain, 2 Band EQ and talkover switch
- « Balanced XLR and Unbalanced RCA dual master outs



DJX350USB

- « Rugged, reliable, and easy-to-operate 3-channel DJ mixer.
- « 3-Band EQ per channel for smoother mixing
- « USB port for direct plug and play or connecting with computer
- « Smooth dual-rail channel fader and crossfader
- « Crossfader slope FLAT or STEEP selection switch
- « Balanced XLR Master Output
- « 6.35 mm TRS Headphone output
- « Headphone Cue Mix with cue blend/split switch.
- « Balanced XLR MIC input with dedicated Gain and 2-Band EQ
- « Individual 5-segment LED array for indicating CHANNEL output levels
- « Individual 10-segment LED array for indicating LEFT & RIGHT output.
- « Separate Master, Record & Booth RCA output.



With Bluetooth and USB

DSP2X3

- « 2-input and 3-output digital sound processor
- « Most Suitable for Fixed Installations
- « 31-band PEQ for input
- « 10-band PEQ for each output
- « Classic Compression and Limiting
- « Friendly software interface.
- « Call system presets directly, and you can get satisfactory sound effects without professional debugging.
- « 1~9 9 preset gears in total (0 is preset to BY PASS)



DSP2X6

- « Feedback Elimination
- « 2.7 Seconds of Alignment and Zone Delay
- « RS-232 PC GUI control
- « Classic Compression and Limiting
- « Graphic and Parametric EQ
- « Auto-EQ Function
- « Full Bandpass, Crossover, and Routing Config.
- « Auto Gain Control
- « Pink Noise Generator and fulltime RTA
- « Security Lockout



DSP4080

- « 4-input and 8-output digital sound processor
- « Wide diapason, natural and delicate timber.
- « Delay: 2S for each Input and 2S for each Output
- « Input 9-band PEQ and Output 9-band PEQ; 31-band GEQ
- « Max stable remote-control distance at 40 meters.
- « Friendly software interface.
- « 30 kinds of system preset.
- « USB, RS232, RS485, or WIFI can be connected to a PC.
- « Both IRR and FIR filters.



With Wifi & FIR Filters

DSP4800A

- « 4-input and 8-output digital sound processor
- « Wide diapason, natural and delicate timber.
- « Use 32 bits floating point unit, made the operation precise.
- « Input 8-band PEQ and Output 6-band PEQ
- « Use 96kHz sampling frequency, one time higher than others.
- « Friendly software interface.
- « 30 kinds of system preset.
- « With IRR filters.





224XS

- « XLR balanced ins and outs
- « Switch Mode for 2-way stereo or 3-way mono operation
- « Low-frequency output (subwoofer)
- « X10 range switch on two channels
- « 40hz Altitude (low cut) filter channels
- « Phase switch on all outputs
- « Personal level control on all outputs
- « 24db for each octave Linkwitz-Riley filter



234XS

- « XLR balanced ins and outs
- « Mode switches for mono 4-way or stereo 2-way/3-way
- « Low frequency summed (subwoofer) output
- « x10 range switch on both channels
- « 40Hz high pass (low cut) filter both channels
- « Phase reverse switch on all outputs
- « Individual level controls on all outputs
- « 24dB per octave Linkwitz-Riley filters



215S

- « Dual 15-band, 1/3-octave Constant Q frequency bands
- « Switchable boost/cut ranges of ± 6 or ± 12 dB
- « Front panel bypass switch
- « ± 12 dB input gain range
- « 4-segment LED ladders for monitoring output levels
- « XLR and TRS Inputs and Outputs
- « Frequency Response of $< 10\text{Hz}$ to $> 50\text{kHz}$
- « Dynamic range of greater than 108dB



SM882

- « Ultra-low noise 8 in/2 out line mixer and 2 in/8 out line splitter
- « Each channel can operate independently in mixer/splitter mode
- « Usable as 6 in/6 out level matching amplifier or DI box
- « Converts levels between -10 dBV and +4 dBu
- « Extremely wide bandwidth from 5 Hz to 200 kHz for the highest signal integrity
- « 6 mono in, 6 mono out, 2 main inputs, and 2 outputs
- « 4/8-segment input/output level meters for all channels



SK-10BT

- 1 x 10" Speaker
- 1 x 1" Compression Driver [HD 25]
- 75W RMS Power for Amplifier
- Built-in **BLUETOOTH**
- 2 Wireless VHF Hand Microphone
- 2 Wire Microphone Input
- 1 Line input / output
- Mp3 Player with USB/SD Card
- Direct Record to USB
- Upto 4 hrs Battery Backup
- TWS function to Connect Two unit wirelessly



SK-12BT

- 1 x 12" Speaker
- 1 x 1" Compression Driver [HD 25]
- 100W RMS Power for Amplifier
- Built-in **BLUETOOTH**
- 2 Wireless VHF Hand Microphone
- 2 Wire Microphone Input
- 1 Line input / output
- Mp3 Player with USB/SD Card
- Rechargeable 12V battery
- Upto 4 hrs Battery Backup
- TWS function to Connect Two unit wirelessly



POWER PLUS

- 1 x 12" Speaker
- 1 x 1" Compression Driver [HD 25]
- 150W RMS Power for Amplifier
- Built-in **BLUETOOTH**
- 2 Wireless VHF Hand Microphone
- 2 Wire Microphone Input
- 1 Line input / output
- Mp3 Player with USB/SD Card
- Rechargeable 12V battery
- Upto 4 hrs Battery Backup
- TWS function to Connect Two unit wirelessly



SK-15BT

- 1 x 15" Speaker
- 1 x 1" Compression Driver [HD 25]
- 100W RMS Power for Amplifier
- Built-in **BLUETOOTH**
- 2 Wireless VHF Hand Microphone
- 2 Wire Microphone Input
- 1 Line input / output
- Mp3 Player with USB/SD Card
- Rechargeable 12V battery
- Upto 6 hrs Battery Backup
- TWS function to Connect Two unit wirelessly



INSTALLATION SERIES



AI SERIES

The AERONS AI series range of installation speakers have been designed for every architectural aesthetic, structural & performance requirement. The series is housed in compact forms that fit into tight spaces, corners & all the variables structural designs.

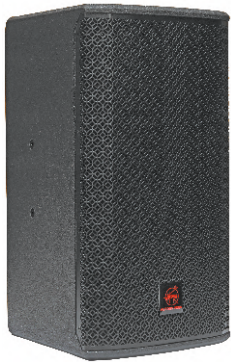

AI 16

- 1X6.5"(165mm)/2" voice coil LF
- 1X1"(25mm)/ 1" voice coil HF
- 200 Watts RMS power
- 90 dB Sensitivity
- Frequency Range: 90Hz-18kHz
- Dispersion: 90° x 50°

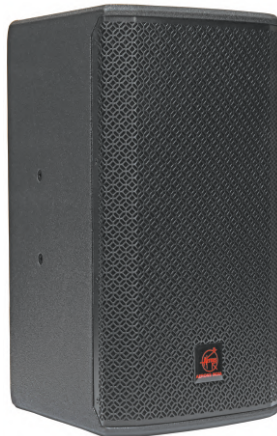

AI 26

- 2X6.5"(165mm)/2" voice coil LF
- 1X1"(25mm)/ 1" voice coil HF
- 400 Watts RMS power
- 93 dB Sensitivity
- Frequency Range: 90Hz-18kHz
- Dispersion: 90° x 50°

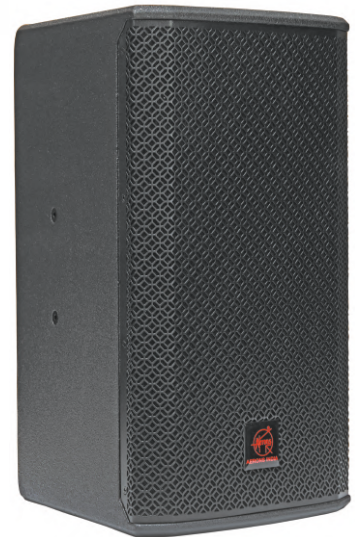

AI 28

- 2X8"(200mm)/2" voice coil LF
- 1X1"(25mm)/ 1.4" voice coil HF
- 450 Watts RMS power
- 96 dB Sensitivity
- Frequency Range: 80Hz-18kHz
- Dispersion: 90° x 50°



AI 118SUB

- 1X18"(460mm)/4.5" voice coil LF
- 1500 Watts RMS power
- 99 dB Sensitivity
- Frequency Range: 40Hz-150Hz
- 133dB Peak SPL
- Impedance: 4 ohms



AI 112SUB

- 1X12"(300mm)/3" voice coil LF
- 500 Watts RMS power
- 96 dB Sensitivity
- Frequency Range: 40Hz-200Hz
- 127dB Peak SPL

NF SERIES (WATER RESISTANCE)

The NF Series are weather-resistant, two-way full range loudspeakers. High durability and superior performance with full sound over a large listening area. These cabinets have a sturdy structure and IP rated system which can be used both indoors and outdoors, being able to withstand the elements. Also, their elegant and discreet design make them the ideal speaker for outdoor installations such as beach clubs, pools, cruise ships and terraces.

• IP66 Rated Water Resistance Speakers

NF-4W

- 1 X4"(100mm)/1" voice coil LF
- 1X0.8"(20mm)/ Dome Tweeter
- 40 Watts RMS power
- 88 dB Sensitivity
- 16 Ohms Impedance

NF-4BT

- 1 X4"(100mm)/1" voice coil LF
- 1X0.8"(20mm)/ Dome Tweeter
- 10W/20W/40W/OFF/16Ω
- 88 dB Sensitivity
- 16 Ohms Impedance

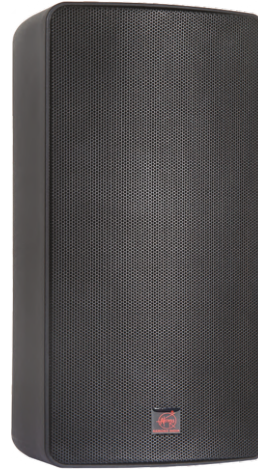
NF-6B

- 1 X6"(150mm)/1.5" voice coil LF
- 1X1"(25mm)/ 1" voice coil HF
- 150 Watts RMS power
- 89 dB Sensitivity
- 16 Ohms Impedance

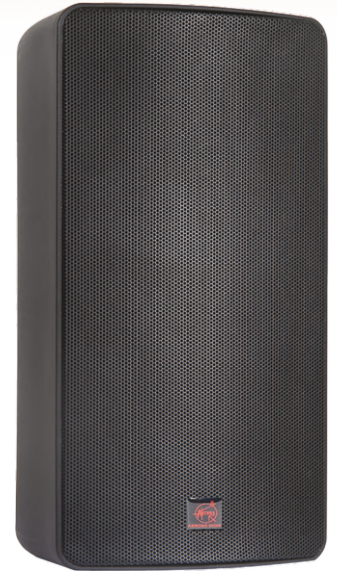
NF-8BT

- 1 X8"(200mm)/2" voice coil LF
- 1X1"(25mm)/ 1" voice coil HF
- 37.5W/75W/150W/OFF/16Ω
- 88 dB Sensitivity
- 16 Ohms Impedance

WS SERIES

The WS series is a 4inch & 6inch, 2-way Loudspeaker series with rich sound character, consistent dispersion, versatile mounting, wide coverage, and a highly designed appearance that blends into a variety of interiors. This makes WS series a Perfect choice for a wide variety of applications, including retail stores, restaurants, Gyms, theme parks, educational institutes, hospitality, cafes, leisure venues, and anywhere where a top quality high-output indoor/outdoor foreground/background music speaker is required.

WS-4WT
WS-6WT

WS-4WT

- 1 X4"(100mm) LF Driver with PP cone
- 1X1"(25mm) Tweeter
- 50 Watts RMS power
- 2.5/5/10/20w/8Ω Tapping
- 89 dB Sensitivity
- 8 Ohms Impedance

WS-6WT

- 1 X6.5"(163mm) LF Driver with PP cone
- 1X1"(25mm) Tweeter
- 100 Watts RMS power
- 5/10/20/40w/8Ω Tapping
- 90 dB Sensitivity
- 8 Ohms Impedance

WB800

- Bearing Weight: $\leq 45\text{kg}$
- Material: Cold-Rolled Steel
- Farthest away from the wall: 115mm
- Horizontally Rotating Angle: $-90^\circ \sim +90^\circ$
- Vertical Angle: $0^\circ \sim 30^\circ$
- Using in/ Colour: Wall Mount Speaker/Black

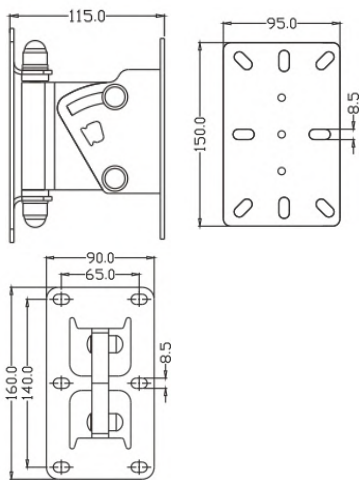
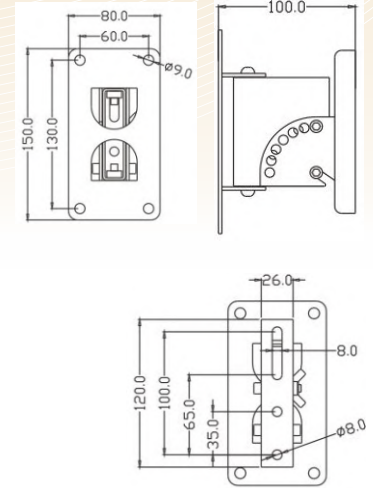

WB900

- Bearing Weight: $\leq 45\text{kg}$
- Material: Cold-Rolled Steel
- Farthest away from the wall: 115mm
- Horizontally Rotating Angle: $-90^\circ \sim +90^\circ$
- Vertical Angle: $0^\circ \sim 30^\circ$
- Using in/ Colour: Wall Mount Speaker/Black

KP590

- Bearing Weight: $\leq 35\text{kg}$
- Material: Cold-Rolled Steel
- Farthest away from the wall: 115mm
- Horizontally Rotating Angle: $-90^\circ \sim +90^\circ$
- Vertical Angle: $0^\circ \sim 30^\circ$
- Using in/ Colour: Wall Mount Speaker/Black

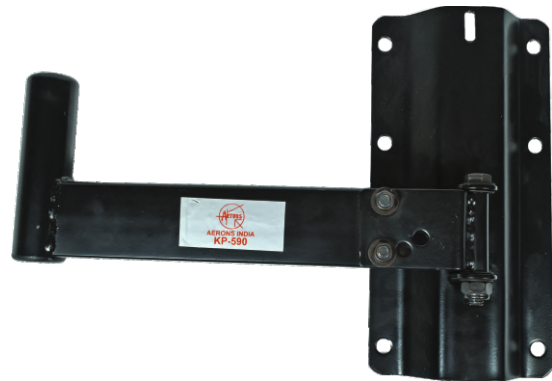

SS180

- Bearing Weight: $\leq 35\text{kg}$
- Material: Cold-Rolled Steel
- Farthest away from the wall: 115mm
- Horizontally Rotating Angle: $0^\circ \sim 360^\circ$
- Vertical Angle: $0^\circ \sim 30^\circ$
- Using in/ Colour: Tripod Speaker stand/Black





AA SERIES

POWERED BY



PROFESSIONAL LOUDSPEAKERS
Made in Italy



AUDIBLE AVENUE LLP



AA3M

- 1x3" (105mm)/ Faitalpro 3FE25
- 16 ohms Impedance
- 20 watts RMS power
- 91dB Sensitivity
- 107dB Peak SPL
- 170Hz to 18Khz Frequency Response
- 60° x 60° Dispersion



AA6F

- 1x6" Faitalpro 6FE100
- 1x HF DE250 Aeron India
- 1x Horn Aeron India
- 8 ohms Impedance
- 100 watts RMS power
- 92dB Sensitivity, 115dB Peak SPL
- 70Hz to 18Khz Frequency Response



AA8M

- 1x8" Faitalpro 8FE200
- 1x HF DE250 Aeron India
- 1x Horn Aeron India
- 8 ohms Impedance
- 130 watts RMS power
- 96dB Sensitivity, 120dB Peak SPL
- 110Hz to 18Khz Frequency Response



AA B10

- 1x10" Faitalpro 10RS350
- 8 ohms Impedance
- 300 watts RMS power, 600 watts Peak Power
- 93dB Sensitivity
- 120dB Peak SPL
- 49Hz to 300Khz Frequency Response
- Omni Directional Dispersion
- Subwoofer cabinet, 6th order band pass



V4000

- Output power: 1200W at 8Ω; 2000W at 4Ω
- Output power 100V: 1200W per Channel
- Stereo and Parallel output modes
- Tunnel-type cooling ensure much higher efficiency and stable performance
- Neutrik 3-pin electronically balanced XLR as input, and LINK plugs R
- Neutrik SpeakON as output, and one 100V four-pole touch-proof terminal strip R
- 32dB/1V/0.775V input sensitivity selection
- Multiple protection functions: Soft start, VHF, DC, Short Circuit, Clip, Over heat





AA 12LT

- « Single 12" Arrayable Top, Bass Reflex Design
- « 1x12" LF Driver with 4" Voice Coil (Faitalpro)
- « 1x1.4" HF Driver with 3" voice coil (Faitalpro)
- « 700W RMS power, 1400W Peak Power
- « Sensitivity: 99dB
- « SPL: 127dB, Peak SPL: 130dB
- « Frequency Response: 60Hz – 19kHz
- « Net Weight: 23 KGS

Arrayable Design



LOADED WITH



MADE IN INDIA

AA 15LT

- « Single 15" Arrayable Top, Bass Reflex Design
- « 1x15" LF Driver with 4" Voice Coil
- « 1x1.4" HF Driver with 3" voice coil (Faitalpro)
- « 800W RMS power, 1600W Peak Power
- « Sensitivity: 99dB
- « SPL: 127dB, Peak SPL: 130dB
- « Frequency Response: 60Hz – 19kHz
- « Net Weight: 30 KGS

Arrayable Design



HF LOADED WITH



MADE IN INDIA

AA B18

- « 18" Hard Bass Subwoofer, Front Loaded Design
- « 1x18" LF Driver with 4" Voice Coil (FaitalPro)
- « 1200W RMS power, 2400W Peak Power
- « Sensitivity: 98dB
- « SPL: 129dB, Peak SPL: 132dB
- « Frequency Response: 30Hz – 1kHz
- « Net Weight: 53 KGS



LOADED WITH



MADE IN INDIA



AUDIOCENTER

Together we are stronger



SA3 SERIES

DSP Controlled Active Speakers



SA3118

- Active DSP-controlled Compact 18" subwoofer
- Rated Power (Peak): 2000W
- 1x Customized driver, 4"voice coil (LF)
- SPL (Continues/ Peak): 128dB/134Db
- Frequency Response: 20Hz-6KHz
- Class D Built-in Amplifier
- Presets: 80Hz, 100Hz, 120Hz
- Net Weight: 43Kg

SA3218

- Active DSP-controlled Dual 18" subwoofer
- Rated Power (Peak): 4000W
- 2x Customized driver, 4"voice coil (LF)
- SPL (Continues/ Peak): 134dB/140Db
- Frequency Response: 20Hz-6KHz
- Class D Built-in Amplifier
- Presets: 80Hz, 100Hz, 120Hz
- Net Weight: 70Kg





SA3 SERIES

DSP Controlled Active Speakers

SA310

- Active DSP-controlled Full Range 10" Speaker in Wooden Cabinet
- Rated Power (Peak): 2000W
- 1x Custom driver, 2"voice coil (LF)
- 1x Custom driver, 1" exit, 1.75" voice coil(HF)
- SPL (Continues/ Peak): 124dB/130dB
- Frequency Response: 57Hz-20KHz
- Net Weight: 14.5Kg



- 2000W PEAK POWER
- Wooden Cabinet
- EQ Adjustable
- Unique Horn Design
- Class D Amplifier
- Portable



2000W PEAK POWER

Wooden Cabinet

EQ Adjustable

Unique Horn Design

Class D Amplifier

Portable



SA312

- Active DSP-controlled Full Range 12" Speaker in Wooden Cabinet
- Rated Power (Peak): 2000W
- 1x Custom driver, 2.5"voice coil (LF)
- 1x Custom driver, 1" exit, 1.75" voice coil(HF)
- SPL (Continues/ Peak): 126dB/132dB
- Frequency Response: 48Hz-20KHz
- Net Weight: 20Kg



- 2000W PEAK POWER
- Wooden Cabinet
- EQ Adjustable
- Unique Horn Design
- Class D Amplifier
- Portable

SA315

- Active DSP-controlled Full Range 15" Speaker in Wooden Cabinet
- Rated Power (Peak): 2000W
- 1x Custom driver, 3"voice coil (LF)
- 1x Custom driver, 1" exit, 1.75" voice coil(HF)
- SPL (Continues/ Peak): 128dB/134dB
- Frequency Response: 44Hz-20KHz
- Net Weight: 27Kg

MA SERIES

DSP Controlled Active Plastic Speakers



Audiocenter

Dynamic Audio Solutions



MA12

- Active DSP-controlled Full Range 12" Speaker in Polypropylene Plastic Cabinet
- Rated Power (Peak): 1600W
- 1x Custom driver, 2.5" voice coil (LF)
- 1x Custom driver, 1" exit, 1.4" voice coil (HF)
- SPL (Peak): 131dB
- Frequency Response: 50Hz-20KHz
- Net Weight: 14Kg

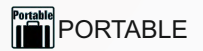
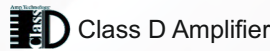
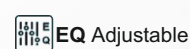

MA15

- Active DSP-controlled Full Range 15" Speaker in Polypropylene Plastic Cabinet
- Rated Power (Peak): 1600W
- 1x Custom driver, 3" voice coil (LF)
- 1x Custom driver, 1" exit, 1.4" voice coil (HF)
- SPL (Peak): 133dB
- Frequency Response: 45Hz-20KHz
- Net Weight: 17.5Kg



MA118

- Active DSP-controlled Single 18" Subwoofer in Wooden Cabinet
- Rated Power (Peak): 2000W
- 1x Custom driver, 4" voice coil (LF)
- SPL (Continuous/Peak): 128dB/134dB
- Frequency Response: 32Hz-150Hz
- Presets: 80Hz, 100Hz, 120Hz
- Net Weight: 39Kg



ACTIVE LINE ARRAY & BASS

DSP Controlled Active Line Array and Bass

AUDIOCENTER

Dynamic Audio Solutions



K-LA12A

- Active DSP-controlled 12" Line Array
- Rated Power (Peak): 2000W
- 1x Customized driver, 3"voice coil (LF)
- 2x Customized driver, 1.75" voice coil(HF)
- SPL (Continues/ Peak): 135dB/141dB
- Frequency Response: 47Hz-19KHz
- Net Weight: 31Kg



T45DSP

- Active DSP-controlled Line Array
- Very compact, lightweight and modular Line Array
- Rated Amp Power (RMS): 1400W
- 4x5" LF Driver
- 2x1" HF Driver
- SPL (Continues/ Peak): 130dB/136dB
- Frequency Response: 63Hz-20KHz
- Net Weight: 18Kg



K-LA218DSP

- Active DSP-controlled Dual 18" subwoofer
- Rock solid humidity free plywood cabinet
- Rated Power (RMS): 2800W
- 2x Customized driver, 4"voice coil (LF)
- In-built Class D Amplifier
- SPL (Continues/ Peak): 135dB/141dB
- Frequency Response: 32Hz-400Hz
- Net Weight: 101Kg

PASSIVE LINE ARRAY & BASS



K-LA28

- Dual 8-Inch Passive Line Array
- Rated Power (A.E.S): LF: 400W, HF: 50W
- 2x Custom driver, 2"voice coil (LF)
- 1x Custom driver, 1"exit, 1.75"voice coil (HF)
- SPL (Continues/ Peak): 122dB/128Db
- Frequency Response: 57Hz-20KHz
- Rated Impedance: 8 (+1, -1)
- Net Weight: 19Kg



K-LA210

- Dual 10-Inch Passive Line Array
- Rated Power (A.E.S): LF: 500W, HF: 70W
- 2x Custom driver, 2.5"voice coil (LF)
- 1x Custom driver, 1.4"exit, 2.84"voice coil (HF)
- SPL (Continues/ Peak): 129dB/135Db
- Frequency Response: 57Hz-20KHz
- Rated Impedance: 8 (+1, -1)
- Net Weight: 33.5Kg



K-LA218

K-LA218 is built with 2 customized 18" LF drivers with 4" voice coil, D.F.L. (Dual Frequency Loading) technology and advanced cooling system, which ensures very low power compression and high SPL, increases response speed and decreases inertial offset at the most.

- Rated Power (A.E.S): 2000W
- Customized 18" driver, 4" voice coil
- SPL (Continues/ Peak): 134dB/140Db
- Rated Impedance: 4 (+2, -2)
- Net Weight: 85Kg

PRO SERIES

Mid- High Level PRO Amplifier



- A-Guard Protection System
- Smart Overheat Management
- Class H+ Circuit Diagram

- Slew Rate 45V/μs
- 9V Input limiter

Rated power (20Hz-20kHz, <0.1%THD)	PRO7.0	PRO9.0	PRO12.0
8 Ohms	2x700W	2x1000W	2x1200W
4 Ohms	2x1100W	2x1500W	2x1800W
2 Ohms	2x1400W	2x1950W	2x2000W
8 Ohms Bridge	2200W	3000W	3600W
8 Ohms Bridge	2800W	3900W	4000W



AERONS (INDIA)

Authorised Dealer Network

Scan QR Code



For Detailed Info.

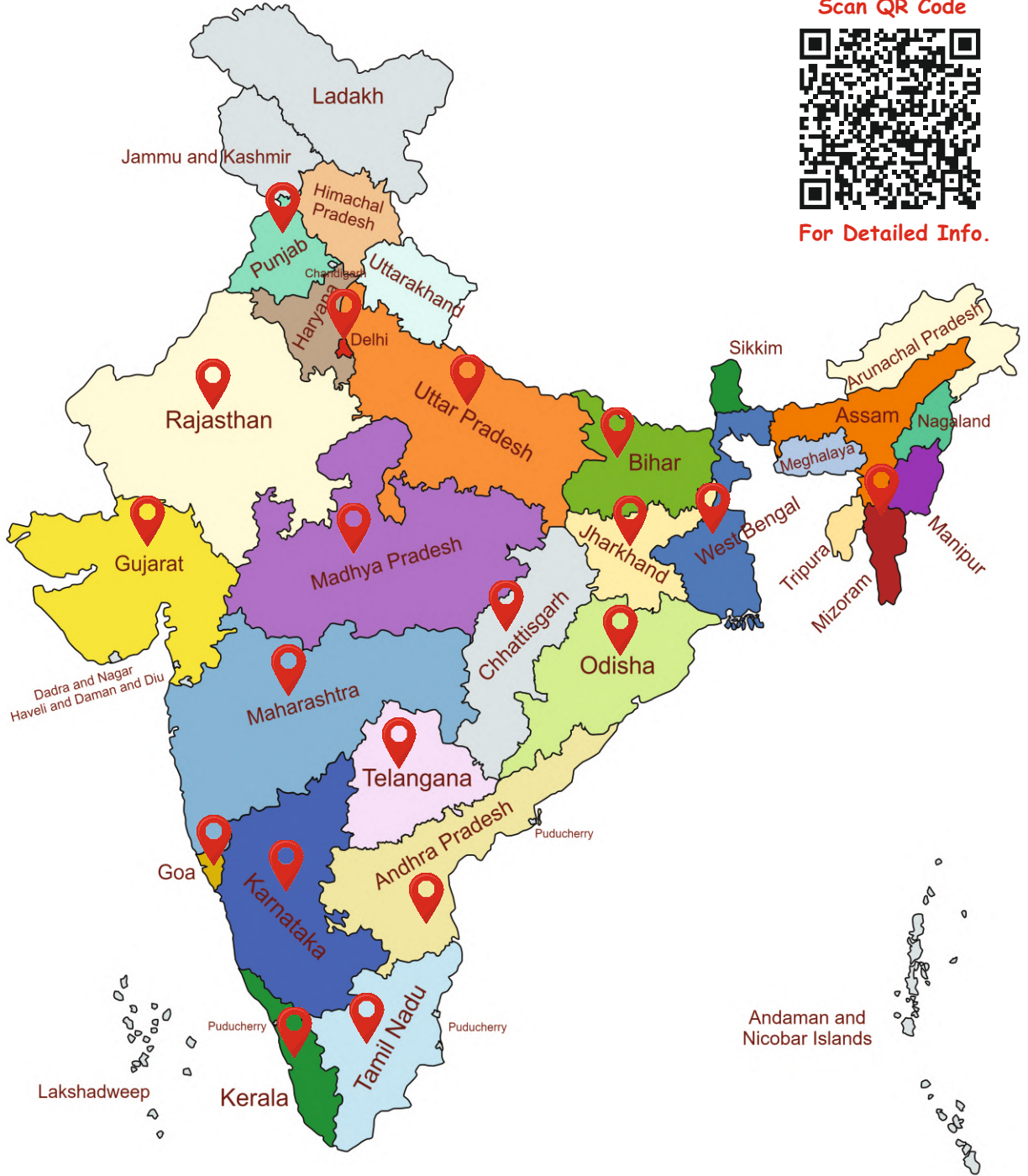

- Andhra Pradesh**
- ◆ Guntur
 - ◆ Vijaywada
 - ◆ Visakhapatnam

- Bihar**
- ◆ Biharsharif, Nalanda

- Chhattisgarh**
- ◆ Raipur
 - ◆ Rajnandgaon

- Delhi**
- ◆ Shivaji Enclave
 - ◆ Chandni Chowk
 - ◆ Bhagirath Palace

- Gujrat**
- ◆ Ahmedabad
 - ◆ Bhuj
 - ◆ Navsari
 - ◆ Rajkot
 - ◆ Vadodra

- Jharkhand**
- ◆ Jharia, Dhanbad

- Karnataka**
- ◆ Bangalore
 - ◆ Nipani

- Kerala**
- ◆ Kundra
 - ◆ Kottayam
 - ◆ Thodupuzha
 - ◆ Thiruvananthapuram

- Madhya Pradesh**
- ◆ Indore

- Maharashtra**
- ◆ Pune
 - ◆ Nagpur
 - ◆ Mumbai
 - ◆ Amravati

- Punjab**
- ◆ Bhatinda
 - ◆ Khamanon

- Mizoram**
- ◆ Aizwal

- Rajasthan**
- ◆ Jaipur

- Odisha**
- ◆ Cuttack
 - ◆ Jharsuguda

- Tamil Nadu**
- ◆ Chennai

- Uttar Pradesh**
- ◆ Lucknow

- West Bengal**
- ◆ Kolkata



AERONS (INDIA) EXIM PVT. LTD

PHONE: 011-35001090, 8929923030
E-MAIL: SALES@AERONSINDIA.COM
WWW.AERONSINDIA.COM

C-155, NARAINA INDUSTRIAL AREA, PHASE-1,
NEW DELHI-110028 (INDIA)

*TO IMPROVE THE QUALITY & PERFORMANCE OF THE PRODUCTS THE SPECIFICATIONS & DESIGNS CAN BE CHANGED WITHOUT PRIOR NOTICE.